

# Series CT7N Bimetallic Overload Relays

Choose CT7N overloads in DC applications and when monitoring Variable Frequency Drives



Sprecher + Schuh provides outstanding motor protection with our CT7N Bimetallic Overload Relay

Sprecher + Schuh has always paid particular attention to the subject of motor protection. This concern is reflected in our CT7N line of thermal overload relays which include many standard features not available with the eutectic alloy overload blocks and heater elements of the past.

## Consistent and reliable protection

The consistent high quality of Sprecher + Schuh thermal overload relays is ensured by a complex, factory current calibration procedure performed on each unit at full operating temperature. Calibration is performed at the largest and smallest current the overload can handle. The accurate time/current characteristic curve obtained in this manner guarantees reliable motor protection every time.

## Superior Class 10 characteristics

Today's T-Frame motors have less copper and iron than the old U-Frame motors that were popular when traditional Class 20 overload relays were designed. For this reason, faster Class 10 overloads like the CT7N Series have been recognized by many motor manufacturers as the ideal type to assure optimum protection of "T" frame motors with applications involving normal start-up conditions.

## Protection from single phase conditions

A unique feature not found in traditional thermal overload relays provides accelerated tripping under single phase conditions. This is accomplished with a special "differential tripping" mechanism built into CT7N (see illustration at right).

## Ambient temperature compensation

All Sprecher + Schuh thermal overload relays are temperature compensating. An additional bimetallic ambient compensation strip, built into the conductor-bimetal transmission path, ensures that the tripping characteristics of the relay remain constant over an ambient temperature range of  $-20^{\circ}\text{C}$  to  $+60^{\circ}\text{C}$ .

## Single phase applications

CT7N Series thermal overload relays can be applied for protection of single phase AC motors. The relays have the same characteristics as shown for three phase operation. To maintain these characteristics, each element of the overload relay must carry the motor current as shown in the connection diagram on page B49.

## Other standard features



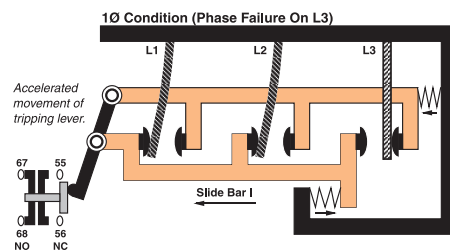



CT7N bimetallic overload relays feature a selectable reset permitting manual or automatic reset modes. A separate NO signal contact is also provided on CT7N overloads, which is isolated from the NC trip contact. This permits the use of a trip signal voltage different than that of the control voltage. The CT7N is also designed to close-couple connect directly to our CA7 contactors, resulting in a compact package.

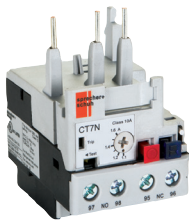

CT7N Bimetallic Overload Relays offer accelerated tripping under single phase conditions

#### CT7N Bimetallic Overload Relays, Manual or Automatic Reset ①④

**B**  
CT7N Overloads

Overload Relay	Directly Mounts to Contactor...	Adjustment Range (A)②③	Trip Class 10
			Catalog Number
 CT7N-23-C16	CA7-9...CA7-23	0.10...0.16	CT7N-23-A16
		0.16...0.25	CT7N-23-A25
		0.25...0.40	CT7N-23-A40
		0.35...0.50	CT7N-23-A50
		0.45...0.63	CT7N-23-A63
		0.55...0.80	CT7N-23-A80
		0.75...1.0	CT7N-23-B10
		0.90...1.3	CT7N-23-B13
		1.1...1.6	CT7N-23-B16
		1.4...2.0	CT7N-23-B20
		1.8...2.5	CT7N-23-B25
		2.3...3.2	CT7N-23-B32
		2.9...4.0	CT7N-23-B40
		3.5...4.8	CT7N-23-B48
		4.5...6.3	CT7N-23-B63
		5.5...7.5	CT7N-23-B75
		7.2...10	CT7N-23-C10
		 CT7N-37-C30	CA7-30...CA7-37
11.3...16	CT7N-23-C16		
15...20	CT7N-23-C20		
17.5...21.5	CT7N-23-C21		
21...25	CT7N-23-C25		
15...20	CT7N-37-C20		
 CT7N-85-C90	CA7-43...CA7-55	17.5...21.5	CT7N-37-C21
		21...25	CT7N-37-C25
		24.5...30	CT7N-37-C30
		29...36	CT7N-37-C36
 CT7N-85-C90	CA7-60...CA7-97	33...38	CT7N-37-C38
		17...25	CT7N-43-C25
		24.5...36	CT7N-43-C36
 CT7N-85-C90	Separate mounting required (Panel or DIN-Rail mounted device)	35...47	CT7N-43-C47
		35...47	CT7N-55-C60
		45...60	CT7N-85-C60
		58...75	CT7N-85-C75
		72...90	CT7N-85-C90
 CT7N-85-C90	Separate mounting required (Panel or DIN-Rail mounted device)	85...97	CT7N-85-C97
		35...47	CT7N-85-C47P
		45...60	CT7N-85-C60P
		58...75	CT7N-85-C75P
		72...90	CT7N-85-C90P
 CT7N-85-C90	Separate mounting required (Panel or DIN-Rail mounted device)	85...97	CT7N-97-C97
		85...97	CT7N-97-C97P





① CT7N Bimetallic Overload Relays can be used with AC contactors, Electronic DC contactors (CA7-9E...55E) and Two-Winding DC contactors (CA7-60D...97D).

② To select the setting range for use in Wye-Delta Starters, multiply the rated operating current of the motor by a factor of 0.58.

③ For motors with service factor of 1.15 or greater, use motor nameplate full load current. For motors with service factor of 1.0, use 90% of the motor nameplate full load current.

④ Under phase loss condition, this 3-phase two slider bar tripping mechanism will trip in approximately 45 seconds.



**Accessories**

Enclosure	Description	For Use With...	Catalog Number
	<b>DIN-rail / Panel Mount Adapter -</b> For separately mounting thermal overload relays	CT7N-23..37	<b>CT7N-37-P-A</b>
	<b>Screw Adapter -</b> For screw fixing of the CT7N-37-P-A panel adapter (1 required per adapter) Pkg. of 10.	CT7N-37-P-A	<b>Use KT7-45-AS</b>
	<b>Remote Reset Solenoid -</b> For remote resetting of the overload relay	CT7N ③ CT8	<b>CMR7N-*</b> <i>Replace * with coil code below</i>
	<b>External Reset Button -</b> Used for manually resetting overloads mounted in enclosures	CT7N all	<b>Use D7 Reset</b>
	<b>Adaptor External Reset -</b> Mounts on relay reset button and provides larger actuation surface.	CT7N ③ CT8	<b>CT7N-RA3</b>

**CMR7N Remote Reset Coil Codes**

A.C. Coil Code	Voltage Range ④			D.C. Coil Code	Voltage ⑤
	50 Hz	60 Hz	50 / 60 Hz		
24Z	~	~	24V	24D	24VDC
48Z	~	~	48V	48D	48VDC
120	110V	120V	~	110D	110VDC
240Z	~	~	220...240V	125D	125VDC

**Marking Systems ①**

Component	Description	Pkg. Qty.	Catalog Number
	<b>Label Sheet –</b> 1 sheet with 105 self-adhesive paper labels each, 6 x 17mm	1	<b>CA7-FMS</b>
	<b>Marking Tag Sheet -</b> 1 sheet with 160 perforated paper labels each, 6 x 17mm. To be used with transparent cover.	1	<b>CA7-FMP</b>
	<b>Transparent Cover -</b> To be used with Marking Tag Sheets.	100 ②	<b>CA7-FMC</b>

① The labeling field of the overload relay may also be written on by hand.

② Minimum order quantity is one package of 100. Price each x 100 = package price.

③ CMR7N-\* and CT7N-RA3 will not mount on separate mount versions of CT7N.

④ Coil consumption of AC coils is 8VA.

⑤ Coil consumption of DC coils is 12 watts.

#### Electrical Data

B  
CT7N Overloads

Main Circuits			CT7N
Rated Insulation Voltage $U_i$	[V]		690
Rated Impulse Strength $U_{imp}$			
Between main poles and between main poles & auxiliaries			6
Between auxiliary circuits	[kV]		4
Rated Operating Voltage $U_e$			
	IEC	[V AC]	690
		[V DC]	440
	UL, CSA	[V AC]	600
Rated Frequencies		[Hz]	50/60
Power dissipation			
	up to 0.4 A	[W]	7
CT7N-23...37	0.5...36 A	[W]	6
	38 A	[W]	12
CT7N-43...55	25...47 A	[W]	12
CT7N-85...97	47...90 A	[W]	18

Lifespan			
Stop function, operates the release contact 95-96	Mechanical	[Mil. ops.]	0.25
	Electrical, at max. contact rating	[Mil. ops.]	0.25

Trip Class	CT7N-23/37	CT7N-43/55/85/97
	IEC/EN 60947-4-1	10A
	UL	10

**Trip Rating** (ultimate tripping current) 125% FLA

**Phase Loss Sensitivity:** Trip rating at phase loss 115% FLA

Reset mode Automatic or Manual

Test release Manual release of auxiliary contacts

Trip indicator Flag visible through opening on front of relay

Approximate weight (unpackaged)	CT7N-23	Weight
	CT7N-37-C20...25	.115 kg
	CT7N-37-C30...38	.155 kg
	CT7N-45/55	.330 kg
	CT7N-85	.360 kg
	CT7N-85- <u>P</u>	.415 kg

Control Circuits			CT7N
Rated Operating Current $I_c$			
AC-15	24V	[A]	4
	240V	[A]	2
	400V	[A]	1.6
	690V	[A]	0.15
DC-13	24V	[A]	2
	110V	[A]	0.4
	220V	[A]	0.25
	440V	[A]	0.08
Thermal Current $I_{th}$			5
Short Circuit withstand, Fuse	IEC, gL/gG	[A]	6
Short-circuit withstand, circuit breaker ≤ 1kA prospective short-circuit-current		[A]	4
Min. contact load for reliable operation			15V, 2 mA

Approvals	UL Rating	A600/Q300
	CSA	C22.2 No. 14
	cULus	E33916, NKCR, NKCR7
	IEC/EN	6094 S7-1, -4-1, -5-1

Operating Limits		CMR7N
Maximum Command Impulse		5s
AC 50/60Hz	Pick-up [ $x U_s$ ]	0.8...1.1
	Drop-out [ $x U_s$ ]	
DC	Pick-up [ $x U_s$ ]	0.7...1.25
	Drop-out [ $x U_s$ ]	

Coil Consumption		
AC 50/60Hz	Pick-up [VA-W]	
	Hold-in [VA-W]	
DC	Pick-up [ $x U_s$ ]	17 (24, 110, 125V) 25 (48V)
	Drop-out [ $x U_s$ ]	17 (24, 110, 125V) 25 (48V)

Terminations	Main Circuits						Control Circuits	Remote Reset
	CT7N-23-A16...C25	CT7N-37-C20...25	CT7N-37-C30...38	CT7N-43 CT7N-55	CT7N-85 CT7N-97	CT7N-37-P-A	CT7N	CMR7N
Terminal Cross-Sections								
Terminal Type	M4	M4	M4	M5	M6	M4	M3.5	M3.5
Terminal Screws								
Fine stranded with Ferrule	[mm <sup>2</sup> ] 2x (1.5...4)	2x (1.5...4)	1x (2.5...10)	1x (2.5...16)	1x (10...35)	1x (1.5...10)	2x (1...4)	2x (1...2.5)
Solid or Course Stranded	[mm <sup>2</sup> ] 2x (1.5...6)	2x (1.5...6)	1x (2.5...16)	1x (2.5...25)	1x (10...35)	1x (1.5...16)	2x (1...4)	1x (1...2.5)
	[AWG] 2x (16...10)	2x (14...10)	1x (10...6)	1x (10...6)	1x (8...1)	1x (16...6)	2x (18...12)	1x (16...12)
Recommended Torque	[Nm] 1.5...2.2	1.5...2.2	2.5...3.5	2.5...3.5	4.5...6	1.8...2.8	1.2	1.2
	[lb-in] 13...20	13...20	22...31	22...31	40...53	16...25	10.6	10.6
Pozidrive Screwdriver	Size 2	2	2	2	~	2	2	2
Slotted Screwdriver	mm .8 x 5.5	.8 x 5.5	.8 x 5.5	.8 x 5.5	~	.8 x 5.5	.8 x 5.5	.8 x 5.5
Hexagon Socket Screw	Size ~	~	~	~	4	~	~	~

## General Data

	CT7N	CT7N
Type of overload relay	Bimetallic, Ambient Compensated, Phase Loss Sensitive	
Compensation temperature range	-20...+60°C (-4...+140°F)	
Type of Protection in connected state	IP00 IP2X (in a connected state)	
Finger Protection	Safe from touch by fingers and back of hand (VDE 0106, Part 100)	
Materials	RoHS compliant	
Flame Resistivity (Outer housing parts)	UL94: V0	
Environmental		
Climatic Conditions	Storage Temp. Range	-55...+80°C
	Operating Temperature Range	-20...+60°C
Vibration	Air moisture (Storage/Operating) (per IEC/EN 60068-2-6), service	5...95% rel. humidity 3g
	IEC/EN 61373 (vibration railways)	cat. 1, class B
	IEC/EN 60092-504 (vibration ships), service	0.7g all axes, 2-200 Hz
Shock	(per IEC/EN 6800-2-27), transport	30g
	IEC/EN 60068-2-27 (shock half-sinus) service (per IEC/EN 61373 (shock railways))	11 ms > 5 g cat. 1, class B
Max. Altitude		2000 m
Pollution Degree		3

## Thermal Overload Relay Maximum Fuse

**B**

CT7N Overloads

For Use With...	Catalog Number	Adjustment Range (A)	Max. Back-up fuse [A]		
			gL/gG 50 kA, 690V AC IEC/EN 60947-4-1 Coordination		UL Class K5 5 kA, 600V AC
			Type 1	Type 2	UL 508
CA7-9...CA7-23	CT7N-23-A16	0.10...0.16	50	~	1
	CT7N-23-A25	0.16...0.25		~	1
	CT7N-23-A40	0.25...0.40		2	1
	CT7N-23-A50	0.35...0.50		2	2
	CT7N-23-A63	0.45...0.63		2	2
	CT7N-23-A80	0.55...0.80		4	3
	CT7N-23-B10	0.75...1.0		4	3
	CT7N-23-B13	0.90...1.3		6	4
	CT7N-23-B16	1.1...1.6		6	5
	CT7N-23-B20	1.4...2.0		10	8
	CT7N-23-B25	1.8...2.5		16	10
	CT7N-23-B32	2.3...3.2		16	12
	CT7N-23-B40	2.9...4.0		16	15
	CT7N-23-B48	3.5...4.8		16	15
	CT7N-23-B63	4.5...6.3		20	20
	CT7N-23-B75	5.5...7.5		25	25
	CT7N-23-C10	7.2...10		25	35
	CT7N-23-C12	9.0...12.5		35	50
CT7N-23-C16	11.3...16	35	60		
CT7N-23-C20	15...20	80	40	80	
CT7N-23-C21	17.5...21.5		50	80	
CT7N-23-C25	21...25		50	100	
CA7-30...CA7-37	CT7N-37-C20	15...20	80	40	80
	CT7N-37-C21	17.5...21.5		50	80
	CT7N-37-C25	21...25		50	100
	CT7N-37-C30	24.5...30	100	63	100
	CT7N-37-C36	29...36	125	63	125
	CT7N-37-C38	33...38		63	150
CA7-43...CA7-55	CT7N-43-C25	17...25	100	50	100
	CT7N-43-C36	24.5...36	125	80	125
	CT7N-43-C47	35...47	160	100	175
	CT7N-55-C60	45...60	200	125	150
CA7-60...CA7-97	CT7N-85-C47	35...47	160	100	175
	CT7N-85-C60	45...60	200	125	250 ①
	CT7N-85-C75	58...75	200	125	300 ①
	CT7N-85-C90	72...90	250	160	350 ①
	CT7N-97-C97	85...97	250	160	250 ①
Separate mounting required (Panel-mounted device)	CT7N-85-C47P	35...47	160	100	175 ②
	CT7N-85-C60P	45...60	200	125	250 ①②
	CT7N-85-C75P	58...75	200	125	300 ①②
	CT7N-85-C90P	72...90	250	160	350 ①②
	CT7N-97-C97P	85...97	250	160	250 ①②

① Max. Back-up fuse [A], UL Class K5, 10 kA, 600V AC

② Only in combination with CA7 Contactors.

**Connection Diagrams**

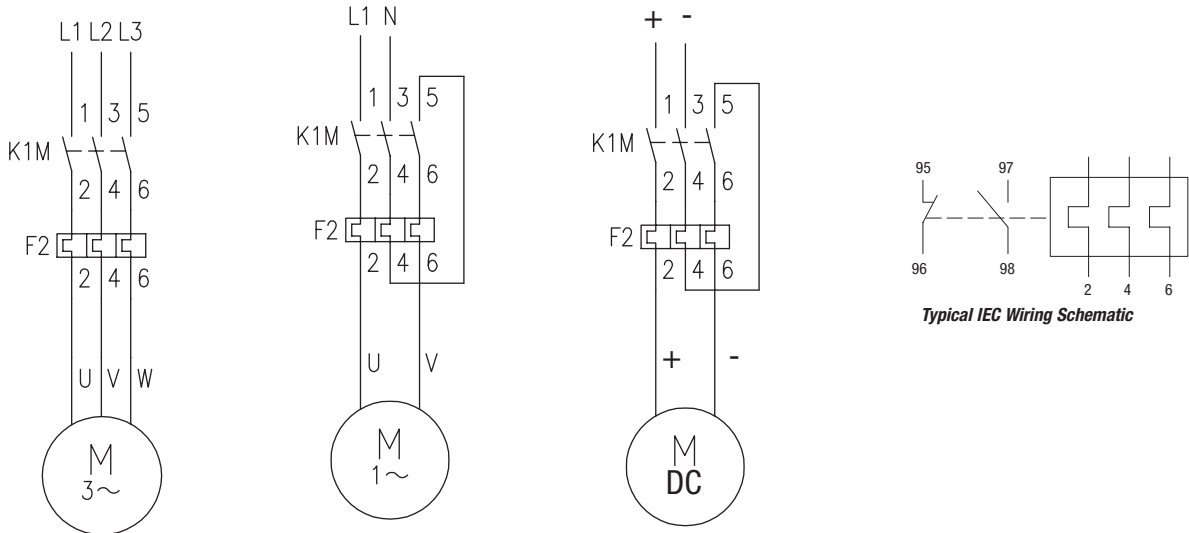

**Tripping Characteristics**

These tripping characteristics refer to IEC/EN 60947-1 and are average values from cold start at an ambient temperature of 20°C. Trip time is pictured as a function of operating current. With the device at max. operating temperature, the trip time decreases to approximately 25% of the shown value.

- (a) Tripping characteristics 3-poles from the cold state
- (b) Tripping characteristics 2-poles from the cold state

CT7N-23-A16...A40 Overload Relays

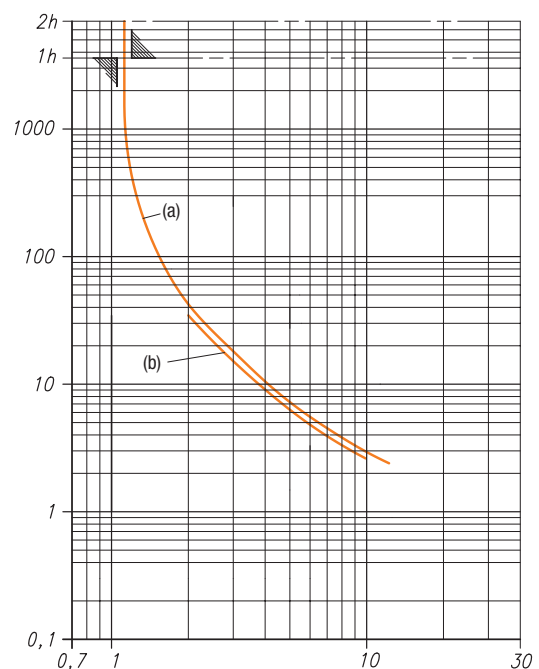

Tripping Characteristics (Continued)

**B**  
CT7N Overloads

CT7N-23-A50...B40 Overload Relays

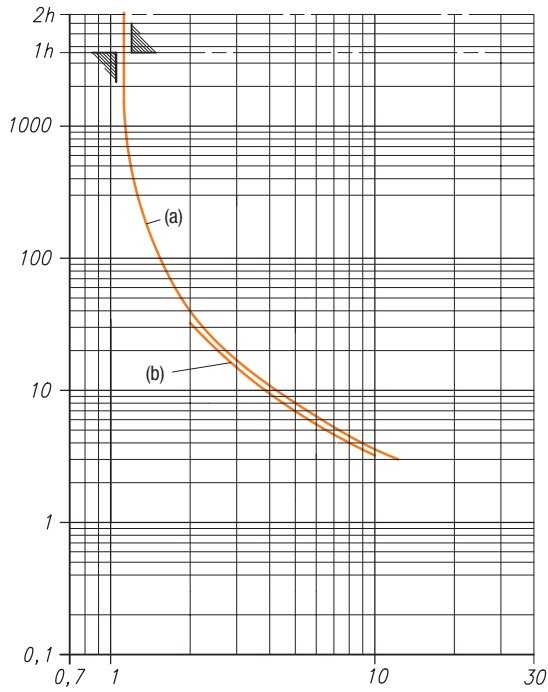

CT7N-23-B48...C25 Overload Relays

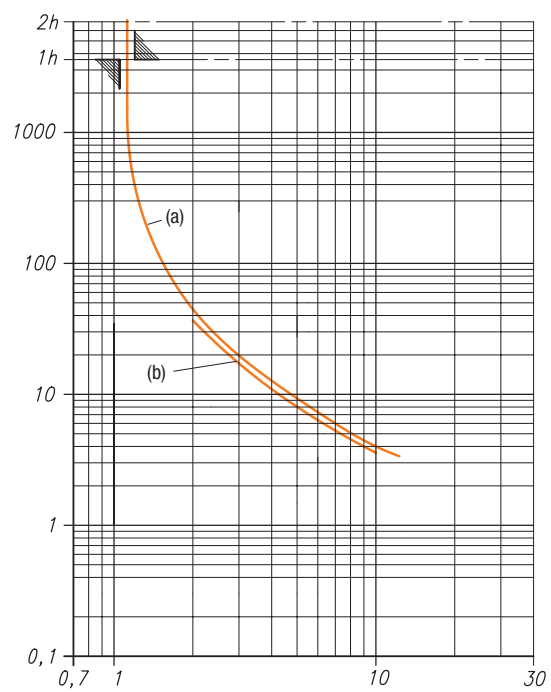

CT7N-37-C20...C25 Overload Relays

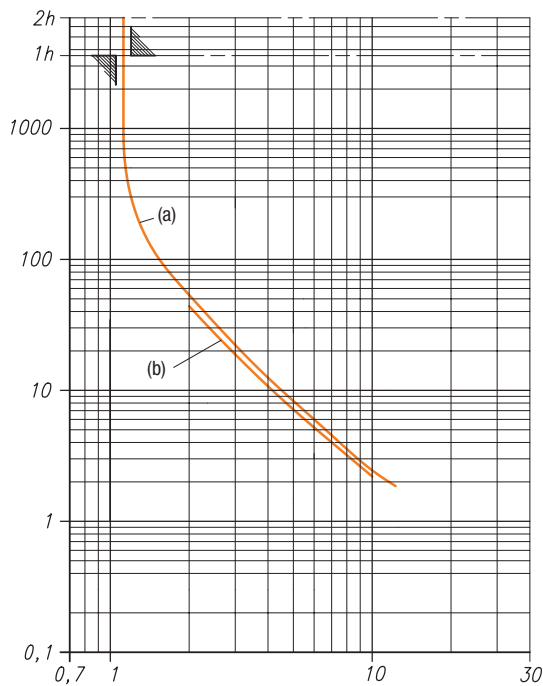

CT7N-37-C30...C38 Overload Relays

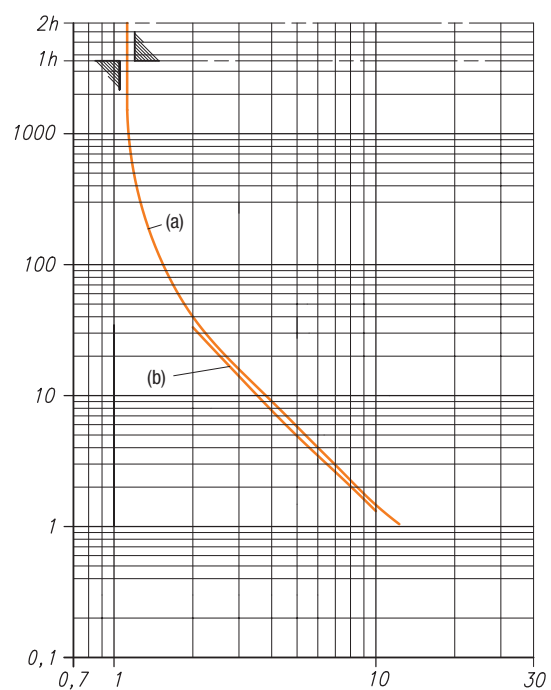

Tripping Characteristics (Continued)

CT7N-43-C25...C47 Overload Relays

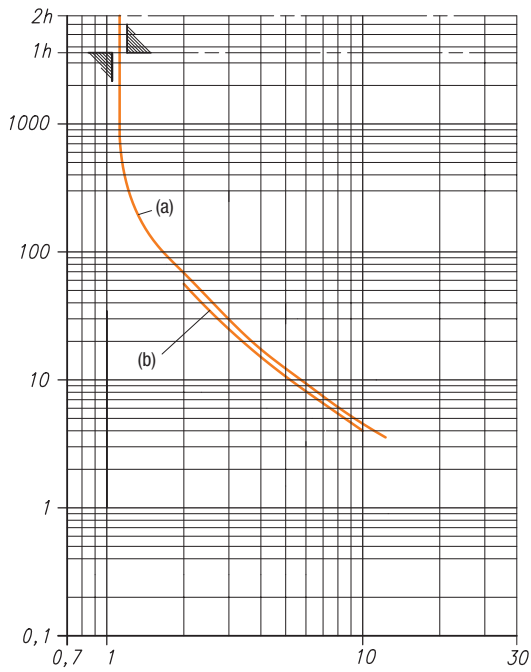

CT7N-85-C47...C90 Overload Relays

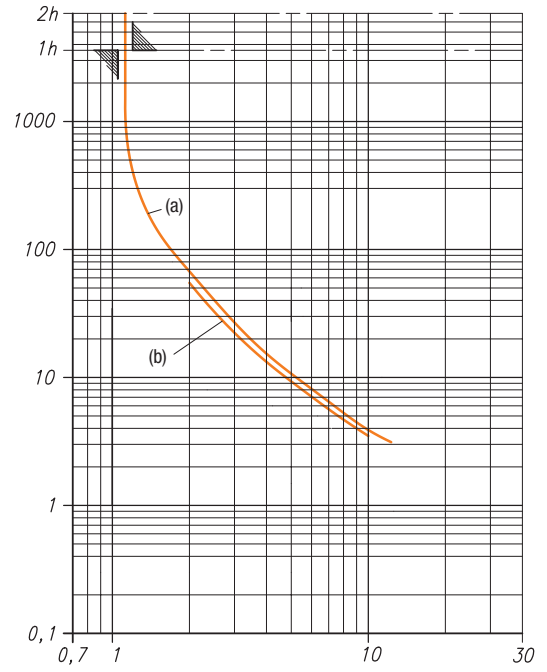

**Series CT7N (Mounting to CA7 Contactors)**

Dimensions are in millimeters (inches). Dimensions not intended for manufacturing purposes.

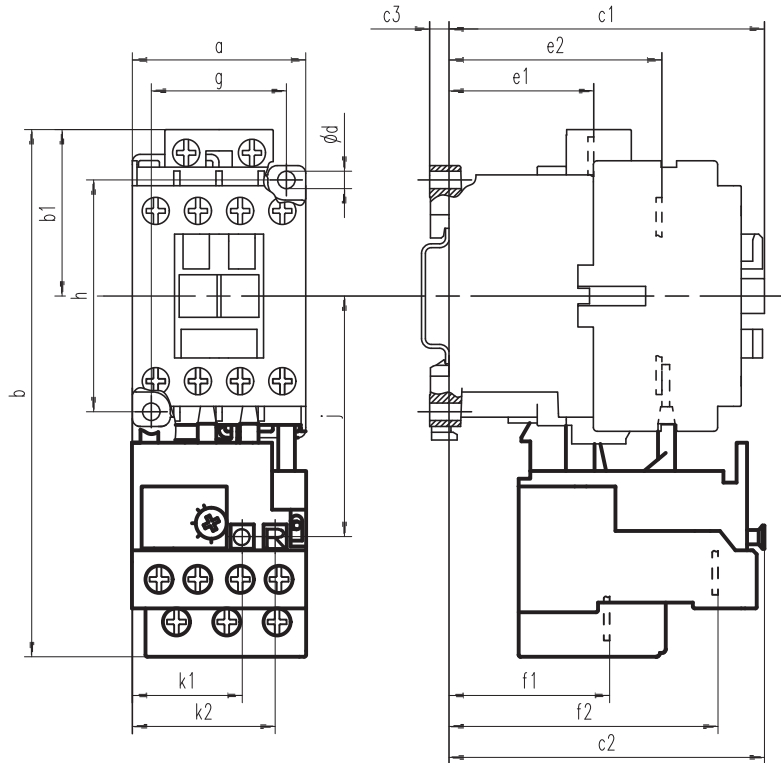

Contactor + Overload	a	b	b1	c1	c2	c3	ød	e1	e2	f1	f2	g	h	j	k1	k2
CA7-9...23 + CT7N-23-A16...C25	45 (1-25/32)	136.5 (5-3/8)	43 (1-11/16)	81.5 (3-13/64)	80.5 (3-11/64)	5 (13/64)	4.5 (3/16)	37.5 (1-15/32)	55 (2-11/64)	40.5 (1-19/32)	68.5 (2-45/64)	35 (1-3/8)	60 (2-23/64)	63.5 (2-1/2)	29 (1-9/64)	37.5 (1-15/32)
CA7-30...37 + CT7N-37-C20...C25	45 (1-25/32)	136.5 (5-3/8)	43 (1-11/16)	99.5 (3-28/32)	89 (3-1/2)	5 (13/64)	4.5 (3/16)	37.5 (1-15/32)	60.5 (2-3/8)	45.5 (1-51/64)	73 (2-7/8)	35 (1-3/8)	60 (2-23/64)	63.5 (2-1/2)	29 (1-9/64)	37.5 (1-15/32)
CA7-30...37 + CT7N-37-C30...C38	45 (1-25/32)	149 (5-55/64)	43 (1-11/16)	99.5 (3-28/32)	89 (3-1/2)	5 (13/64)	4.5 (3/16)	37.5 (1-15/32)	60.5 (2-3/8)	47 (1-27/32)	73 (2-7/8)	35 (1-3/8)	60 (2-23/64)	63.5 (2-1/2)	29 (1-9/64)	37.5 (1-15/32)
CA7-43 + CT7N-43-C25...C47	54 (2-1/8)	149 (5-55/64)	43 (1-11/16)	102 (4-1/64)	100 (3-15/16)	5 (13/64)	4.5 (3/16)	37.5 (1-15/32)	61 (2-13/32)	48 (1-57/64)	88 (3-15/32)	45 (1-25/32)	60 (2-23/64)	66.5 (2-5/8)	34 (1-11/32)	42.5 (1-43/64)
CA7-55 + CT7N-55-C60	54 (2-1/8)	149 (5-55/64)	43 (1-11/16)	102 (4-1/64)	100 (3-15/16)	5 (13/64)	4.5 (3/16)	37.5 (1-15/32)	61 (2-13/32)	48 (1-57/64)	88 (3-15/32)	45 (1-25/32)	60 (2-23/64)	66.5 (2-5/8)	34 (1-11/32)	42.5 (1-43/64)
CA7-60...85 + CT7N-85-C47...C90	72 (2-53/64)	191 (7-33/64)	64 (2-33/64)	120 (4-23/32)	108 (4-1/4)	5.5 (7/32)	5.4 (7/32)	45 (1-25/32)	74 (2-29/32)	55.5 (2-3/16)	80 (3-5/32)	55 (2-11/64)	100 (3-15/16)	87.5 (3-7/16)	41.5 (1-41/64)	50 (1-31/32)
CA7-97 + CT7N-97-C97	72 (2-53/64)	191 (7-33/64)	64 (2-33/64)	120 (4-23/32)	108 (4-1/4)	5.5 (7/32)	5.4 (7/32)	45 (1-25/32)	74 (2-29/32)	55.5 (2-3/16)	80 (3-5/32)	55 (2-11/64)	100 (3-15/16)	87.5 (3-7/16)	41.5 (1-41/64)	50 (1-31/32)

**Series CT7N Separate Mount (+ Adaptor)**

Dimensions are in millimeters (inches). Dimensions not intended for manufacturing purposes.

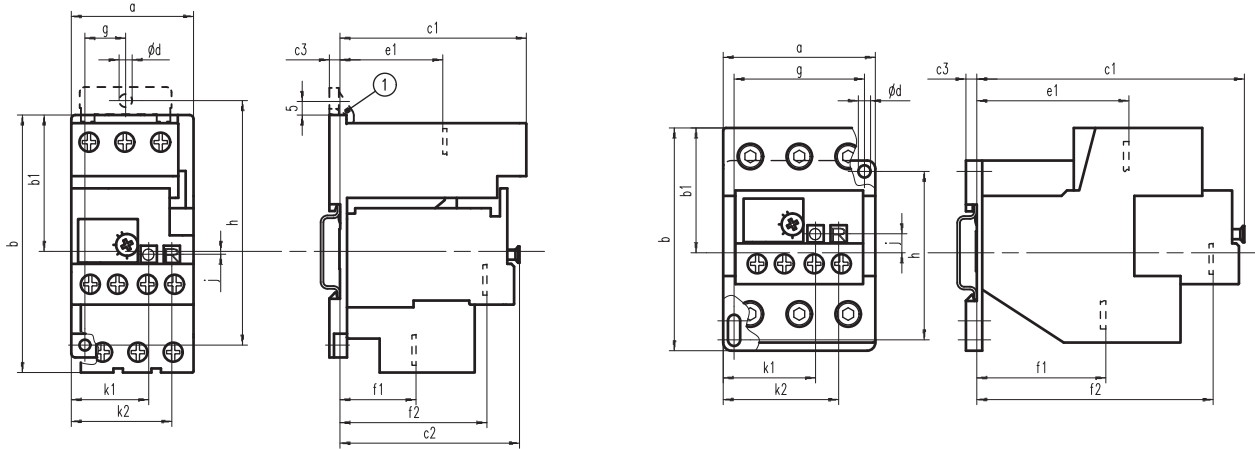

CT7N-23..37 with Panel Mount Adapter

CT7N-85...97 Separate Mount

Overload + DIN Rail/Panel Mounting Adapter	a	b	b1	c1	c2	c3	ød	e1	f1	f2	g	h	k1	k2
CT7N-23-A16...C25 + CT7N-37-P-A	45 (1-25/32)	89.5 (3-17/32)	50 (1-31/32)	69 (2-23/32)	66 (2-19/32)	4 (5/32)	4.5 (3/16)	38 (1-31/64)	26 (1-1/32)	54 (2-1/8)	15 (19/32)	90 (3-35/64)	29 (1-9/64)	37.5 (1-15/32)
CT7N-37-C20...C25 + CT7N-37-P-A	45 (1-25/32)	91.5 (3-39/64)	50 (1-31/32)	69 (2-23/32)	66 (2-19/32)	4 (5/32)	4.5 (3/16)	38 (1-31/64)	28 (1-7/64)	54 (2-1/8)	15 (19/32)	90 (3-35/64)	29 (1-9/64)	37.5 (1-15/32)
CT7N-85-C47P...CT7N-97-C97P	56 (2-13/64)	82 (3-15/64)	46 (1-13/16)	99.5 (3-28/32)	~	4 (5/32)	4.5 (3/16)	56 (2-13/64)	47.5 (1-7/8)	87 (3-27/64)	~	60 (2-23/64)	41.5 (1-41/64)	50 (1-31/32)

**CT7N-RA3 External Reset Adaptor**

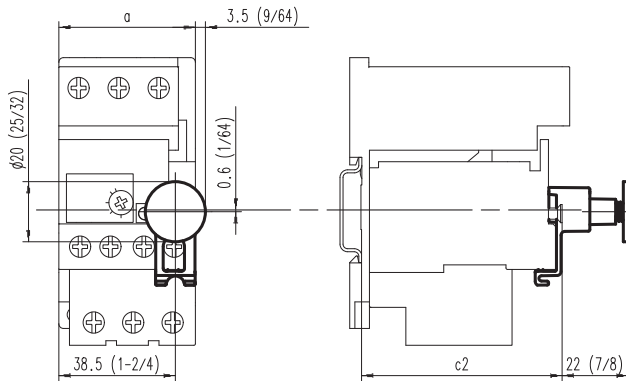

**CMR7N Remote Reset Solenoid**

